

WEISSDORNWEG 11

BV LAFUENTE

4.9.96
[Signature]
 1.9.98

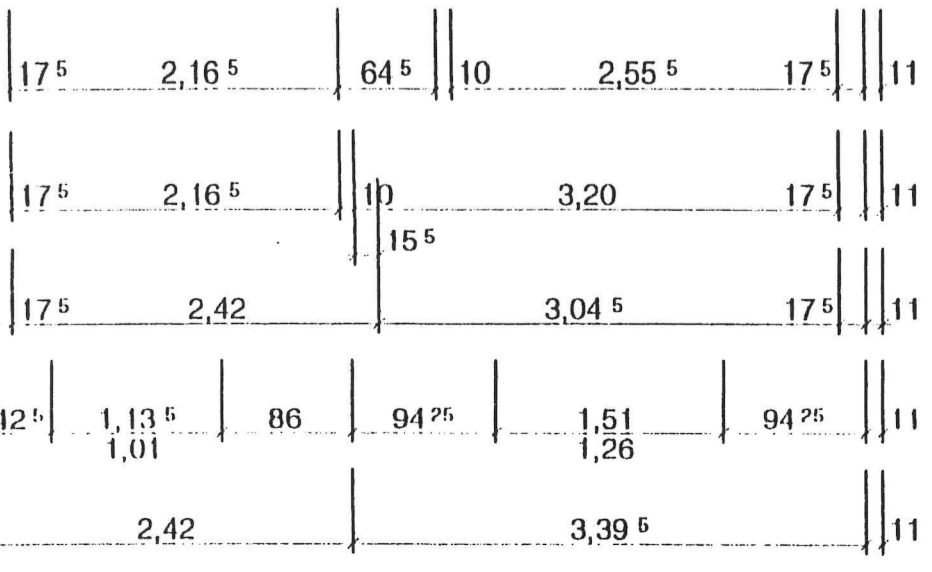
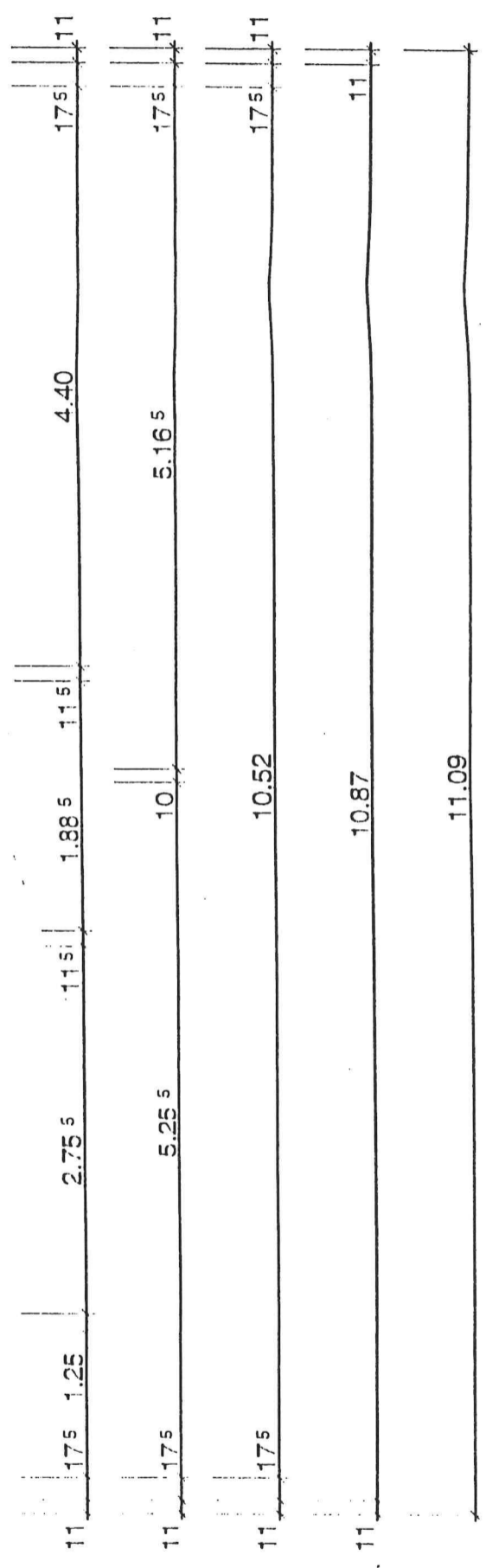
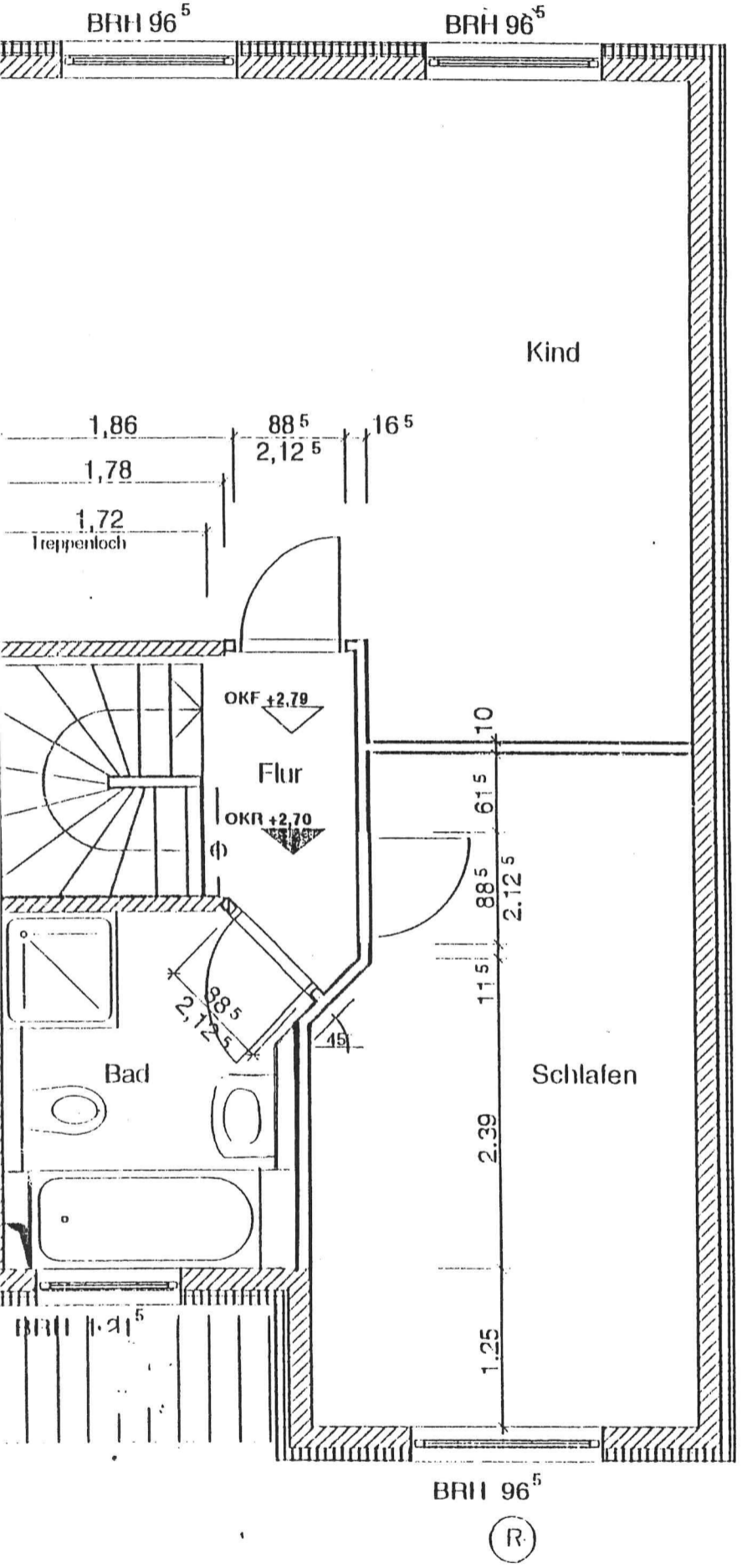
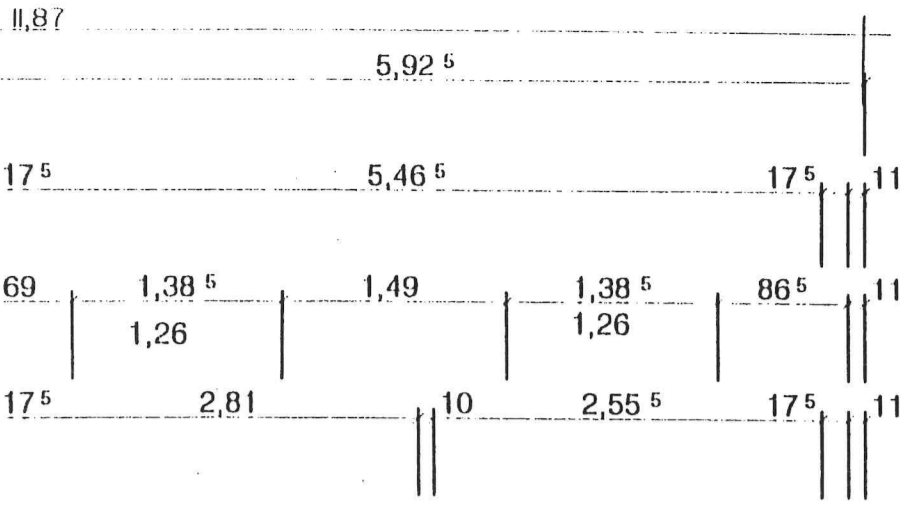

WEISSDORNWEG 11

BV LAFUENTE

JA
1.9.98

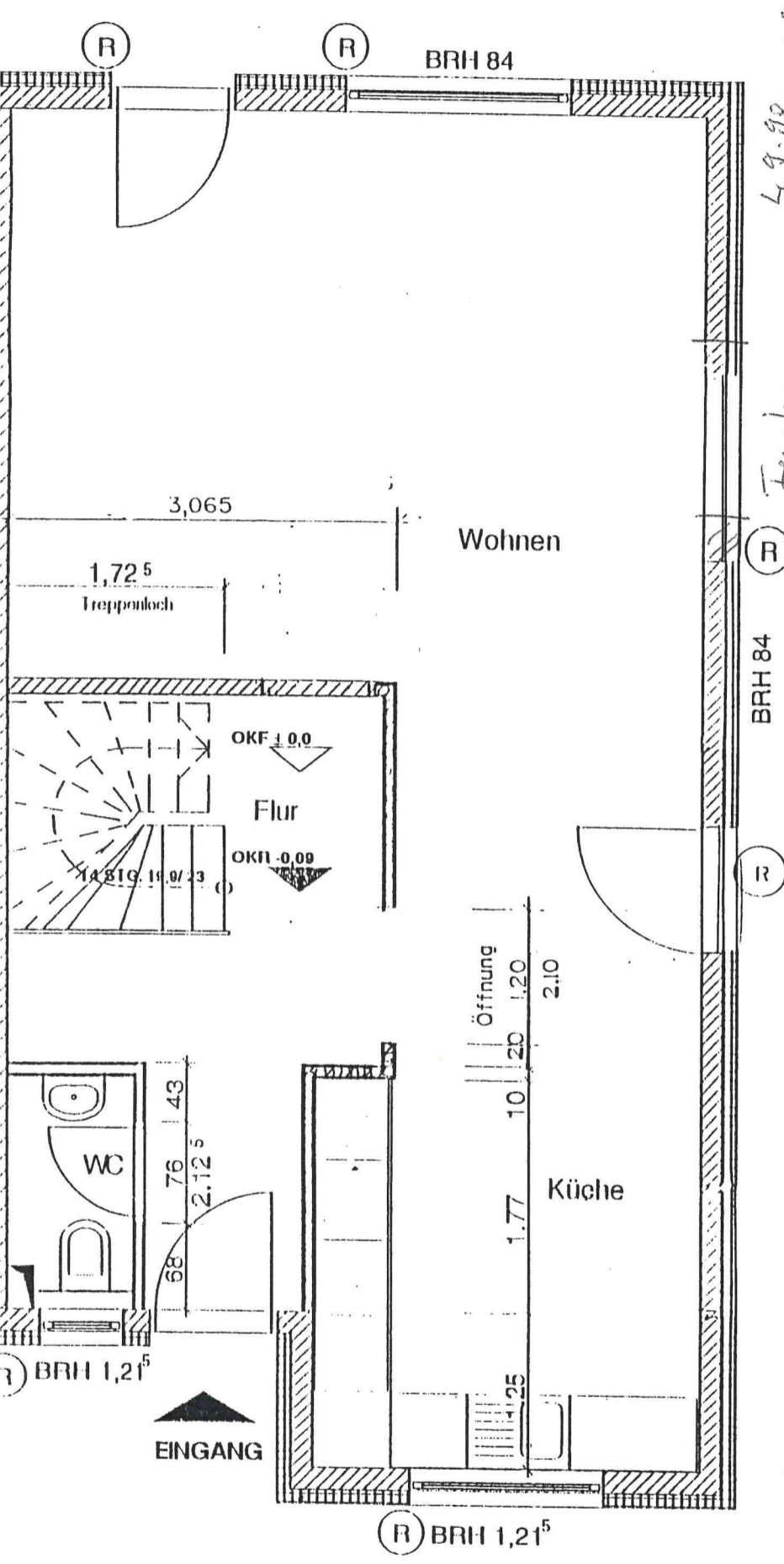
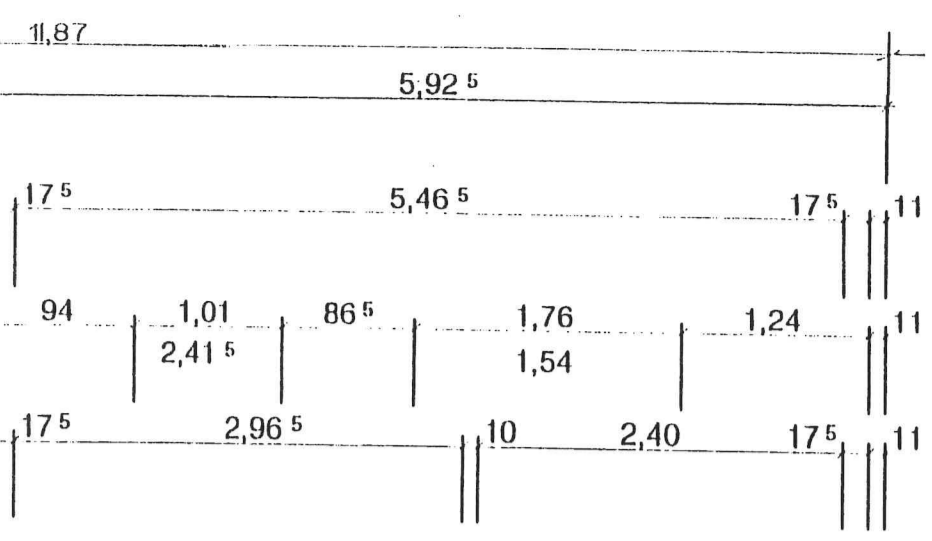

*Le 9.98
Fenster
über Kellerfenster mit Hg*

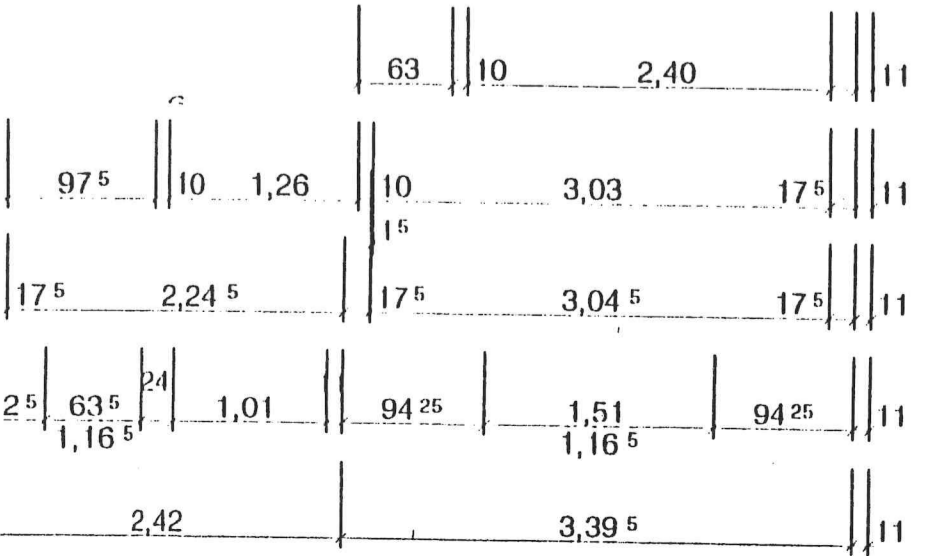
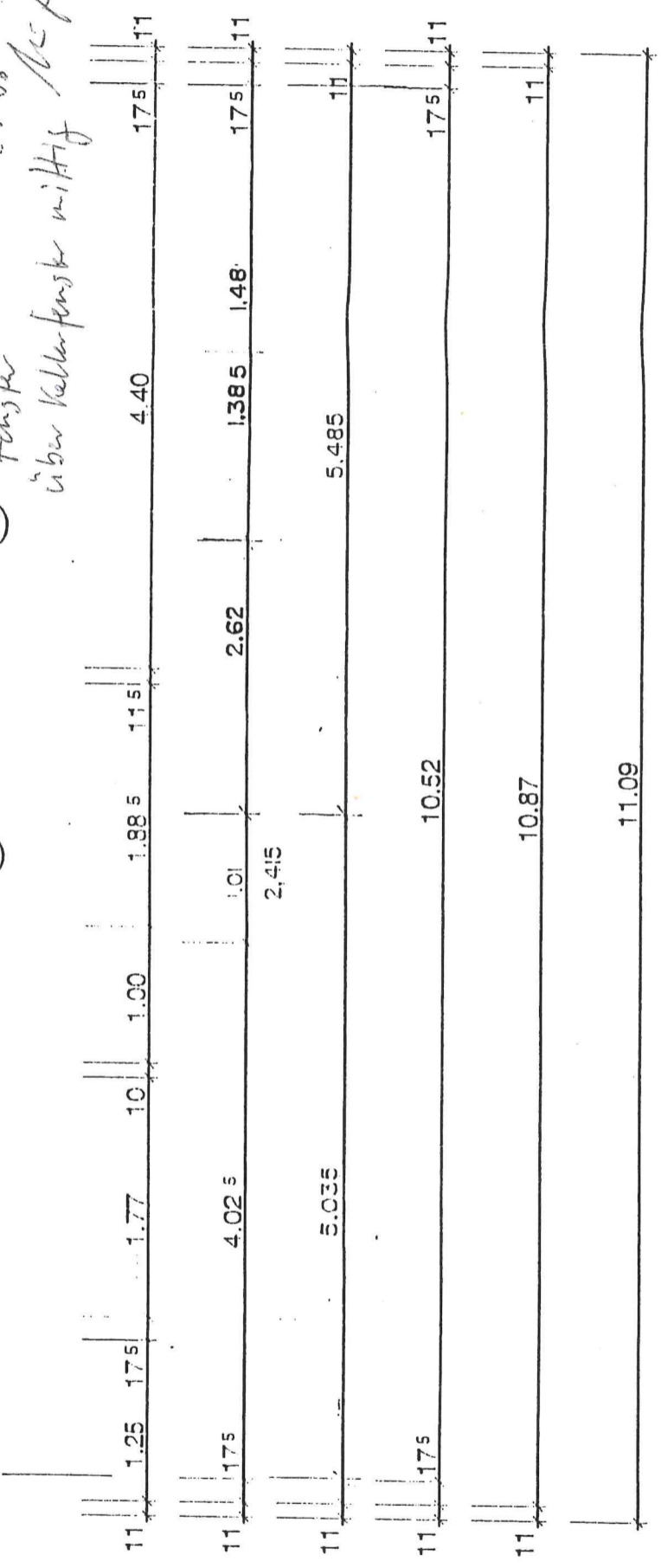

WEISSDORNWEG 11

BV LAFUENTE

9.9.98

